

ELETTROPOMPE AUTOADESCANTI SEMI-TRASH
SELF PRIMING ELECTRIC PUMPS SEMI TRASH-MODEL
ELECTROPOMPES AUTOAMORÇANTES SEMI-TRASH



B4XR-A/ST 15 kW



DESCRIZIONE

Elettropompa autoadescante realizzata in versione monoblocco a girante multipalare aperta a rasamento, adatta per il travaso di acque cariche, con girante e guarnizione meccanica speciali, piatto d'usura in acciaio Inox e portello d'ispezione. Una valvola a clapet posta all'interno del corpo pompa impedisce lo svuotamento della pompa dopo l'arresto.

DESCRIPTION

Self priming electric pump monobloc execution with multi-blades open impeller, suitable for pumping dirty water, with special impeller and special mechanical seal, Inox wear disk and inspection door. A suitable non return valve is placed inside the pump body to avoid the empty after stopping.

DESCRIPTION

Electropompe autoamorçantes monobloc avec turbine ouverte plusieurs pales, indiquée pour le transvasement d'eau chargée, avec turbine et garniture mécanique spéciales, disque d'usure en acier Inox et porte d'inspection. Une valve à clapet est placée dans le corps de la pompe pour éviter le vidage après l'arrêt.

CARATTERISTICHE

Altezza massima di aspirazione: 6 m.
 Max temperatura del liquido: +70°C
 Max passaggio corpi solidi: 39 mm
 Portata massima: 137 m³/h
 Prevalenza massima: 3,4 bar
 Ø aspirazione e mandata: 4" G

FEATURES

*Max. suction depth: 6 m.
 Max. liquid temperature: +70°C
 Max. solids diameter: 39 mm
 Max. delivery: 137 m³/h
 Max. manometric head: 3,4 bar
 Ø inlet / outlet: 4" G*

CARACTERISTIQUES

*Hauteur d'aspiration maximale: 6 m.
 Température Max.: +70°C
 Max. diamètre des solides: 39 mm
 Débit maximum: 137 m³/h
 Hauteur manométrique: 3,4 bars
 Ø aspiration & refoulement: 4" G*

VERSIONE

Corpo pompa: Ghisa
 Corpo valvola: Ghisa
 Supporto motore: Ghisa
 Girante: Ghisa
 Albero motore: Acciaio Inox AISI 316
 Tenuta mecc.: Carb.Silicio/Nbr/Allumina

VERSION

*Pump body: Cast iron
 Valve body: Cast iron
 Support: Cast iron
 Impeller: Cast iron
 Motor shaft: Stainless Steel AISI 316
 Seal: Silicon Carbide/ Nbr/ Alumina*

EXECUTION

*Corps de pompe: Fonte
 Corps valve: Fonte
 Support: Fonte
 Turbine: Fonte
 Arbre moteur: Acier inox AISI 316
 Garniture: Carbure de Silicium/Alumine*

VERSIONI SPECIALI

Tenute meccaniche materiali diversi
 Tensioni speciali
 Frequenza 60Hz

SPECIAL VERSIONS

*Different mechanical seals
 Special voltages
 Frequency 60Hz*

VERSIONS SPECIALES

*Garnitures mécaniques différentes
 Voltages spéciaux
 Fréquence 60Hz*

DATI TECNICI

TECHNICAL DATA

DONNES TECHNIQUES

Tipo Type	P2 (kW)	V (Volt)	Freq. (Hz)	Corrente nominale Rated current Intensité (A)	Protez. Protection	Giri/min RPM Tours/min	Cond. (µF)	Peso Weight Poids (Kg.)	A/B/C (mm)
B4XR-A/ST T.	15	400/690	50	26,5 / 15,4	IP 55	2900	-	228	515x1060x725

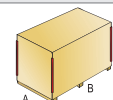

CURVE DI PRESTAZIONE

Tolleranze e curve secondo UNI EN ISO 9906
Appendice A

PERFORMANCES CURVES

Tolerance and curves according to UNI EN ISO 9906
Attachment A

COURBES DE PERFORMANCES

Tolérance et courbes conformes aux normes UNI EN ISO 9906
Annexe A

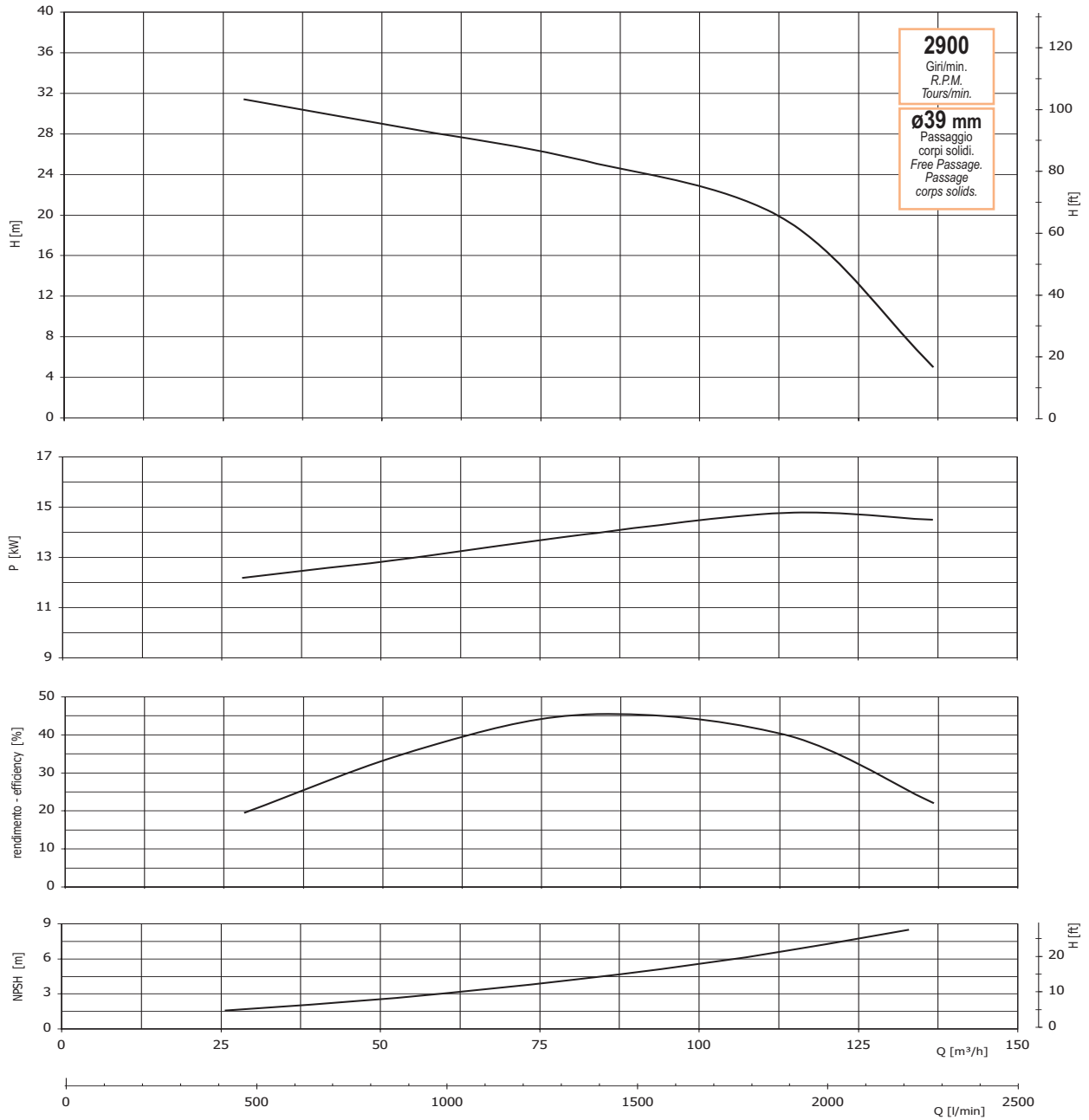

DIMENSIONI

DIMENSIONS

DIMENSIONS

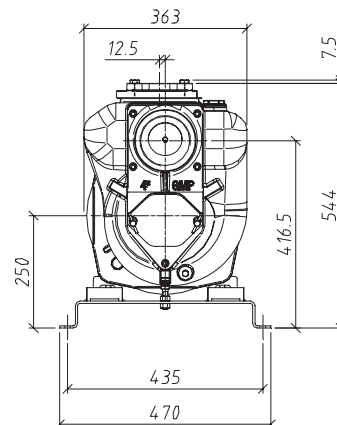
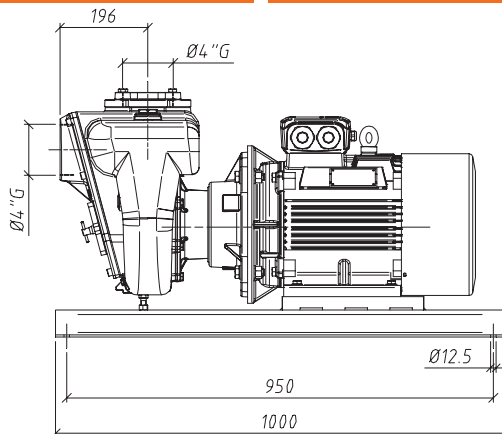

La GMP si riserva la facoltà di modificare senza preavviso i dati riportati in questo catalogo. - GMP can alter without notifications the data mentioned in this catalogue. - GMP se réserve le droit de modifier sans préavis les données techniques dans ce catalogue.